

BESSEY Spann- und Schneidtechnik

Zubehör- und Ersatzteilliste 2017/2018



Einfach besser.



4-7 Temperguss-Schraubzwingen



TG / TPN
TGK / TKPN
TGNT

8-11 Ganzstahl-Schraubzwingen



GZ / GS
G...Z
GU25-12-6ZK

10-11 OMEGA-Schraubzwingen



GMZ

12-13 Hebelzwingen



GH / GSH
GHS / G...H

14-15 Hochleistungs-zwingen



SLM / SGM / SGL /
SG...M / STBM
STBVC / SGU / STBU
STBS / SG30VAD
GSL / GSM

16 Variable Schraubzwingen



SLV / GSV

17 Greifarmzwingen



GRA...12

17 Schnellspanner



STC-VH / STC-HH /
STC-HV / STC-HA
STC-IHH / STC-IHA
TW...A-STC
TW...VAD / TWVAD

18-20 Spannelemente



TWV / TW
TWM28
TW28GRS

21 Maschinentisch-spanner



BAS
BSN
SGHS

22 Korpuszwingen



KR / KR / V / K

23 Flächenspanner



FK

23 Einhandzwingen



EHZ

23 Gripzangen



GRZ
GRZRO

24 Sparrenzwingen



SPZ

25 Schraubspanner



S10

25 Kantenzwinge



EKT

26 Kantenfix und Plattenträger



KF
KFP

26 Bandspanner



BAN

26 Winkelspanner



WS

**27-28 Türfutter- und Fenstermontage-
werkzeuge**



TU / TFM / FRK



TAN / TB / TC

29 Plattenspanner



PS

29 Blechknabber



**29 Klingen-
Klappmesser**



**30 Hebelübersetzte
Scheren**



**31 Normal-
blechscheren**



Die BESSEY Produktentwicklung
behält sich technische Änderungen
vor. Für Druckfehler keine Haftung.

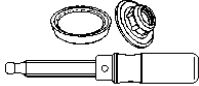
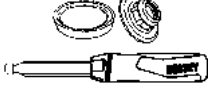

Temperguss-Schraubzwingen

passend für Serie TG und TPN

	Unterteil kpl. mit Holzgriff		Holzgriff inkl. wechselbarer Druckplatte aus Qualitätsstahl mit Schutzkappe			2-Komponenten-Kunststoffgriff inkl. wechselbarer Druckplatte aus Qualitätsstahl mit Schutzkappe		
	Ausladung mm	für Schiene mm	Länge x Ø mm	Kopf Ø mm	Trapezgewinde mm	Länge x Ø mm	Kopf Ø mm	Trapezgewinde mm
TG10 / TG...B5								
Bestell-Nr.	-		-			-		
TG12 / TG...B6								
Bestell-Nr.	-		-			-		
TG 16 TG...B8 TPN 16 TPN...B8						110 x 30	10	14 x 4
Bestell-Nr.	-		-			3101179		
TG 20 TG...S10 TPN 20 TPN...S10	100	27 x 7	112 x 30	12	16 x 4	110 x 30	12	16 x 4
Bestell-Nr.	3101413		3101386			3101182		
TG 25 TG...S12 TPN 25 TPN...S12	120	29 x 9	125 x 32	12	16 x 4	130 x 34	12	16 x 4
Bestell-Nr.	3101414		3101389			3101186		
TG 30 TG...S14 TPN 30 TPN...S14	140	32 x 10	140 x 35	13	18 x 5	130 x 34	13	18 x 5
Bestell-Nr.	3101415		3101390			3101187		
TG 40 TG...S17	175	32 x 10	140 x 35	13	18 x 5	130 x 34	13	18 x 5
Bestell-Nr.	3101416		3101390			3101187		
TPN 40 TPN...S17	175	32 x 10	140 x 35	13	18 x 5	130 x 34	13	18 x 5
Bestell-Nr.	3101416		3101390			3101187		

Temperguss-Schraubzwingen

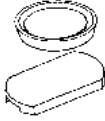
passend für Serie TG und TPN

	Druckplatte mit Schutzkappe wechselbar ab Gr. 16	Schutzkappen für Ober- und Unterteil		Knebelaufsatz KA
				
	4 Stück im Beutel	10 Paar im Beutel		2 Stück im Beutel
	Ø mm	für Ø mm	für Breite OT mm	nur für Knebelvarianten passend
TG10 / TG...B5	22	22	17	
Bestell-Nr.	3101339	3101391		–
TG12 / TG...B6	22	22	19	
Bestell-Nr.	3101339	3101392		–
TG 16 TG...B8 TPN 16 TPN...B8	25,5	25,5	23	
Bestell-Nr.	3101180	3101393		–
TG 20 TG...S10 TPN 20 TPN...S10	32	32	28	
Bestell-Nr.	3101183	3101394		3101194
TG 25 TG...S12 TPN 25 TPN...S12	32	32	30	
Bestell-Nr.	3101183	3101395		3101194
TG 30 TG...S14 TPN 30 TPN...S14	38,5	38,5	32	
Bestell-Nr.	3101188	3101396		3101194
TG 40 TG...S17	38,5	38,5	32	
Bestell-Nr.	3101188	3101396		3101194
TPN 40 TPN...S17	38,5			
Bestell-Nr.	3101188	SKS20/40		3101194

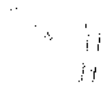
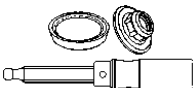
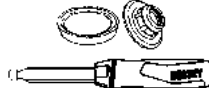

Temperguss-Knechte

passend für Serie TGK und TKPN

	Unterteil kpl. mit Holzgriff		Holzgriff inkl. wechselbarer Druckplatte aus Qualitätsstahl mit Schutzkappe			2-Komponenten-Kunststoffgriff inkl. wechselbarer Druckplatte aus Qualitätsstahl mit Schutzkappe		
								
	Ausladung mm	für Schiene mm	Länge x Ø mm	Kopf Ø mm	Trapezgewinde mm	Länge x Ø mm	Kopf Ø mm	Trapezgewinde mm
TGK TKPN	120	35 x 11	140 x 35	13	18 x 5	130 x 34	13	18 x 5
Bestell-Nr.	3101417		3101390			3101187		
TGK-K	120	35 x 11						
Bestell-Nr.	3101418		-			-		



Temperguss-Knechte

passend für Serie TGK und TKPN

	Druckplatte mit Schutzkappe	Schutzkappenstreifen		Knebelaufsatz KA
				
	4 Stück im Beutel	2 Stück im Beutel		2 Stück im Beutel
	Ø mm	für Ø mm	für Breite OT mm	nur für Knebelvarianten passend
TGK TKPN	38,5	25,5	23	
Bestell-Nr.	3101188	SKS20/40		3101194
TGK-K	38,5	25,5	23	
Bestell-Nr.	3101188	SKS20/40		3101194

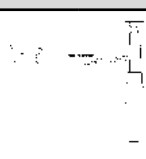
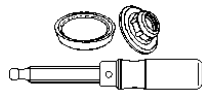

Tiefspan-Schraubzwingen

passend für Serie TGNT

	Unterteil kpl. mit Holzgriff		Holzgriff inkl. wechselbarer Druckplatte aus Qualitätsstahl mit Schutzkappe			Druckplatte mit Schutz- kappe	Knebelaufsatz KA
							
	Ausladung mm	für Schiene mm	Länge x Ø mm	Kopf Ø mm	Trapezgewinde mm	Ø mm	nur für Knebel- varianten passend
TGN...T20	200	35 x 11	140 x 35	13	18 x 5	38,5	
Bestell-Nr.	3101419		3101390			3101188	3101194
TGN...T25	250	40 x 11	140 x 35	13	18 x 5	38,5	
Bestell-Nr.	3101420		3101390			3101188	3101194
TGN...T30	300	45 x 12	140 x 35	13	18 x 5	38,5	
Bestell-Nr.	3101421		3101390			3101188	3101194
TGN...T40			140 x 35	13	18 x 5	38,5	
Bestell-Nr.	-		3101390			3101188	3101194
TGN...T50			140 x 35	13	18 x 5	38,5	
Bestell-Nr.	-		3101390			3101188	3101194

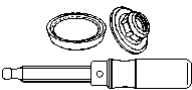
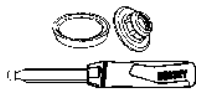

Ganzstahl-Schraubzwingen – neue Version ab 01.07.09

passend für Serie GZ

Gleitbügel kpl. mit Holzgriff		Gleitbügel kpl. mit Knebelgriff		Holzgriff inkl. wechselbarer Druckplatte aus Qualitätsstahl mit Schutzkappe			2-Komponenten-Kunststoffgriff inkl. wechselbarer Druckplatte aus Qualitätsstahl mit Schutzkappe		
									
Ausladung mm	für Schiene mm	Ausladung mm	für Schiene mm	Länge x Ø mm	Kopf Ø mm	Trapezgewinde mm	Länge x Ø mm	Kopf Ø mm	Trapezgewinde mm
GZ 10 / GZ 12									
Bestell-Nr.		-		-		-		-	
GZ 16									
Bestell-Nr.		-		-		-		-	
GZ 20 GZ...-10									
100	22 x 8,5	100	22 x 8,5	112 x 30	12	16 x 4	110 x 30	12	16 x 4
Bestell-Nr.		3101516		3101441		3101386		3101182	
GZ 25 GZ...-12									
120	24 x 9,5	120	24 x 9,5	125 x 32	12	16 x 4	130 x 34	12	16 x 4
Bestell-Nr.		3101517		3101444		3101389		3101186	
GZ 30									
140	28 x 11	140	28 x 11	140 x 35	13	18 x 5	130 x 34	13	18 x 5
Bestell-Nr.		3101518		3101447		3101390		3101187	
GZ 40 - GZ 125									
120	28 x 11	120	28 x 11	140 x 35	13	18 x 5	130 x 34	13	18 x 5
Bestell-Nr.		3101519		3101450		3101390		3101187	

Ganzstahl-Schraubzwingen – neue Version ab 01.07.09

passend für Serie GZ

	Knebelgriff	Druckplatte mit Schutzkappe wechselbar ab Gr. 16	Knebelaufsatz KA
			
		4 Stück im Beutel	2 Stück im Beutel
	Trapezgewinde mm	Ø mm	nur für Knebelvarianten passend
GZ 10 / GZ 12		22	
Bestell-Nr.	–	3101339	–
GZ 16	14 x 4	25,5	
Bestell-Nr.	3100119	3101180	–
GZ 20 GZ...-10	16 x 4	32	
Bestell-Nr.	3100120	3101183	3101194
GZ 25 GZ...-12	16 x 4	32	
Bestell-Nr.	3100120	3101183	3101194
GZ 30	18 x 5	38,5	
Bestell-Nr.	3100121	3101188	3101194
GZ 40 - GZ 125	18 x 5	38,5	
Bestell-Nr.	3100121	3101188	3101194



**OMEGA-Schraubzwingen und Ganzstahl-Schraubzwingen classiX
sowie Ganzstahl-Schraubzwingen – alte Version bis 30.06.09**

passend für Serie GMZ, G...Z, GS

	Gleitbügel kpl. mit Holzgriff		Gleitbügel kpl. mit Knebelgriff		Holzgriff inkl. wechselbarer Druckplatte aus Qualitätsstahl mit Schutzkappe			2-Komponenten-Kunststoffgriff inkl. wechselbarer Druckplatte aus Qualitätsstahl mit Schutzkappe		
	Aus- ladung mm	für Schiene mm	Aus- ladung mm	für Schiene mm	Länge x Ø mm	Kopf Ø mm	Trapez- gewinde mm	Länge x Ø mm	Kopf Ø mm	Trapez- gewinde mm
G10Z / G12Z GS10 / GS12										
Bestell-Nr.	-		-		-			-		
G16Z / GS16										
Bestell-Nr.	-		-		-			-		
G20Z/G...-S10Z GS20 GM 20Z GM...S10Z	100	19,5 x 9,5	100	19,5 x 9,5	112 x 30	12	16 x 4	110 x 30	12	16 x 4
Bestell-Nr.	3101422		3100263		3101386			3101182		
G25Z/G...-S12Z GS25 GM 25Z GM...-S12Z GU25-12-GZK	120	22 x 10,5	120	22 x 10,5	125 x 32	12	16 x 4	130 x 34	12	16 x 4
Bestell-Nr.	3101423		3100264		3101389			3101186		
G30Z / GS30 GM30Z	140	25 x 12	140	25 x 12	140 x 35	13	18 x 5	130 x 34	13	18 x 5
Bestell-Nr.	3101424		3100265		3101390			3101187		
G40Z-G60Z GS40-GS60 GM40Z-GM60Z	120	25 x 12	120	25 x 12	140 x 35	13	18 x 5	130 x 34	13	18 x 5
Bestell-Nr.	3101425		3100266		3101390			3101187		
G80Z-G125Z GS80-GS100 GM80Z-GM125Z	120	27 x 13	120	27 x 13	140 x 35	13	18 x 5	130 x 34	13	18 x 5
Bestell-Nr.	3101426		3100267		3101390			3101187		



OMEGA-Schraubzwingen und Ganzstahl-Schraubzwingen classiX sowie Ganzstahl-Schraubzwingen – alte Version bis 30.06.09

passend für Serie GMZ, G...Z, GS

	Knebelgriff	Druckplatte mit Schutzkappe wechselbar ab Gr. 16	Knebelaufsatz KA
		 4 Stück im Beutel	 2 Stück im Beutel
	Trapezgewinde mm	Ø mm	nur für Knebelvarianten passend
G10Z / G12Z GS10 / GS12		22	
Bestell-Nr.	–	3101339	–
G16Z / GS16		25,5	
Bestell-Nr.	–	3101180	–
G20Z/G...-S10Z GS20 GM 20Z GM...S10Z	16 x 4	32	
Bestell-Nr.	3100120	3101183	3101194
G25Z/G...-S12Z GS25 GM 25Z GM...-S12Z GU25-12-6ZK	16 x 4	32	
Bestell-Nr.	3100120	3101183	3101194
G30Z / GS30 GM30Z	18 x 5	38,5	
Bestell-Nr.	3100121	3101188	3101194
G40Z-G60Z GS40-GS60 GM40Z-GM60Z	18 x 5	38,5	
Bestell-Nr.	3100121	3101188	3101194
G80Z-G125Z GS80-GS100 GM80Z-GM125Z	18 x 5	38,5	
Bestell-Nr.	3100121	3101188	3101194

Hebelzwingen – GH – neue Version ab 01.03.10

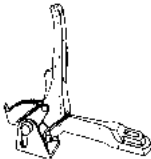

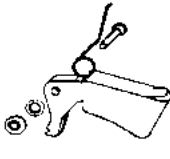
passend für Serie GH

	Gleitbügel kpl.		Hebel mit Druckkappe kpl.	Sperrklinke kpl.
				
				2 Stück im Beutel
	Ausladung mm	für Schiene mm	Bolzen-Ø x l mm	Bolzen-Ø x l mm
GH 12 GH 16				5h11 x 21
Bestell-Nr.	-		-	3101399
GH 20 GH...-10	100	22 x 8,5	10 x 33,5	5h11 x 23
Bestell-Nr.	3101522		3101397	3101400
GH 25 GH...-12	120	24,5 x 9,5	10 x 33,5	5h11 x 23
Bestell-Nr.	3101523		3101397	3101400
GH 30	140	28 x 11	12 x 38	5h11 x 26
Bestell-Nr.	3101524		3101398	3101401
GH 40 - GH 100	120	28 x 11	12 x 38	5h11 x 26
Bestell-Nr.	3101525		3101398	3101401

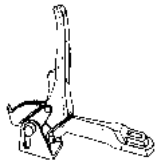
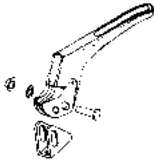
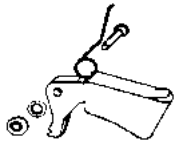

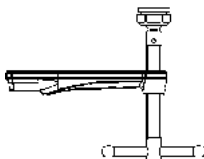
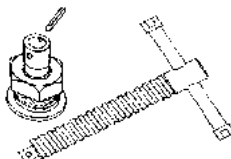

Hebelzwingen classiX – GSH
sowie Hebelzwingen – GH – alte Version bis 28.02.10
 passend für Serie G...H, GSH

	Gleitbügel kpl.		Hebel mit Druckkappe kpl.	Sperrklinke kpl.
	Ausladung mm	für Schiene mm	Bolzen-Ø x l mm	Bolzen-Ø x l mm
				 2 Stück im Beutel
G12H / G...S6H G16H / G...S8H GSH12 - GSH16				5h11 x 21
Bestell-Nr.	-		-	3101399
G20H / G...S10H GSH20	100	19,5 x 9,5	10 x 33,5	5h11 x 23
Bestell-Nr.	3101333		3101397	3101400
G25H / G...S12H GSH25 GU-H	120	22 x 10,5	10 x 33,5	5h11 x 23
Bestell-Nr.	3101334		3101397	3101400
G30H GSH30	140	25 x 12	12 x 38	5h11 x 26
Bestell-Nr.	3101335		3101398	3101401
G40H - G60H GSH40 - GSH60	120	25 x 12	12 x 38	5h11 x 26
Bestell-Nr.	3101336		3101398	3101401
G80H - G100H	120	27 x 13	12 x 38	5h11 x 26
Bestell-Nr.	3101337		3101398	3101401

Hochleistungszwingen – SLM und SGM – **neue Version ab 01.07.08**

	Gleitbügel kpl.		Kombi-Set (Spindel + Spezialdruckplatte + Spannstift)		Knebelaufsatz KA
					
	Ausladung mm	für Schiene mm	Trapezgewinde mm	Knebel Ø x Länge mm	2 Stück im Beutel
SL...M	120	28 x 11	18 x 5	10 x 120	
Bestell-Nr.	3101521		3100398		3101194
SG...M	140	34 x 13	20 x 5	11 x 120	
Bestell-Nr.	3101407		3100399		3101195

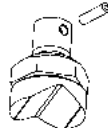
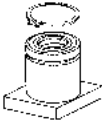



Hochleistungszwingen – SLM/SGM/STBM/STBVC/SGU/STBU/STBS

	Spezial- druckplatte Standard		Spezial druckplatte mit Riffelung		Spezial- druckplatte mit Prisma		Gewinde- buchse mit Sicherungs- ring	Keil STBS	Knebel- aufsatz KA
									
	Spindel- bohrung mm	Spann- stift mm	Spindel- bohrung mm	Spann- stift mm	Spindel- bohrung mm	Spann- stift mm	Gewinde		2 Stück im Beutel
SLM / SGM STBM / STBVC SGU / STBU	12	5 x 20	12	5 x 20	12	5 x 20			
Bestell-Nr.	3100736		3101192		3101193		-	-	3101195
STBS	12	5 x 20					M 24		
Bestell-Nr.	3100737		-		-		3100579	3000689	3101195

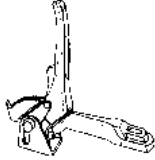

Hochleistungszwingen – STBVC/STB/STBS/SG30VAD
Hochleistungszwingen classiX – GSL und GSM
sowie Hochleistungszwingen – SGL und SGM – alte Version bis 30.06.08

	Gleitbügel kpl.		Kombi-Set (Spindel + Spezialdruckplatte + Spannstift)		Knebelaufsatz KA
	Ausladung mm	für Schiene mm	Trapezgewinde mm	Knebel Ø x Länge mm	2 Stück im Beutel
SGL...M / GSL	120	27 x 13	18 x 5	10 x 120	
Bestell-Nr.	3101338		3100398		3101194
SG...M	120	30 x 15	20 x 5	11 x 120	
Bestell-Nr.	3101329		3100399		3101195
SG30M / GSM / SGU	140	30 x 15	20 x 5	11 x 120	
Bestell-Nr.	3101330		3100399		3101195
SG..T20M	200	30 x 15	20 x 5	11 x 120	
Bestell-Nr.	3101331		3100399		3101195
STB...M/STBU	175	40 x 20	22 x 5	11 x 180	
Bestell-Nr.	3101332		3100400		–
STBS	200	50 x 25	M24	18 x 345	
Bestell-Nr.	3100205		3100401		–
STBVC	100	40 x 20	22 x 5	11 x 180	
Bestell-Nr.	3100753		3100400		–
SG30VAD					
Bestell-Nr.	–		–		3101195

Variable Schraubzwingen SLV, GSV

	Schiene mit 2 Endsicherungen		Gleitbügel kpl. mit Holzgriff		Gleitbügel kpl. mit Hebelgriff		Gleitbügel kpl. mit Knebelgriff		Knebelaufsatz KA
									 2 Stück im Beutel
	Spannweite mm	Schiene mm	Ausladung mm	für Schiene mm	Ausladung mm	für Schiene mm	Ausladung mm	für Schiene mm	nur für Knebelvarianten passend
SLV	1000	27 x 13	120	27 x 13	120	27 x 13	120	27 x 13	
Bestell-Nr.	3101731		3101426		3101337		3101338		3101194
SLV	1500	27 x 13	120	27 x 13	120	27 x 13	120	27 x 13	
Bestell-Nr.	3101732		3101426		3101337		3101338		3101194
SLV	2000	27 x 13	120	27 x 13	120	27 x 13	120	27 x 13	
Bestell-Nr.	3101733		3101426		3101337		3101338		3101194

GSV	3000	30 x 15					120	30 x 15	
Bestell-Nr.	3101612		-		-		3101329		3101195
GSV	3000	30 x 15					140	30 x 15	
Bestell-Nr.	3101612		-		-		3101330		3101195
GSV	3000	30 x 15					200	30 x 15	
Bestell-Nr.	3101612		-		-		3101331		3101195

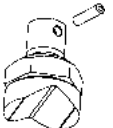
	Spezialdruckplatte Standard		Spezialdruckplatte mit Riffelung		Spezialdruckplatte mit Prisma	
						
	Spindelbohrung mm	Spannstift mm	Spindelbohrung mm	Spannstift mm	Spindelbohrung mm	Spannstift mm
SLV / GSV	12	5 x 20	12	5 x 20	12	5 x 20
Bestell-Nr.	3100736		3101192		3101193	

Greifarmzwingen – neue Version ab 01.04.12

	Greifarm kpl.		Spindel kpl.	
	Ausladung mm	für Schiene mm	Trapezgewinde mm	Knebel Ø x l mm
GRA...12	120	28 x 11	18 x 5	8 x 110
Bestell-Nr.	3101590		3100562	



Schnellspanner STC

	Spindel-Set kpl.	Für Schweißtische			
		Schnellspanner-Adapter		Verlängerung	
		Loch Ø	Loch Ø	Loch Ø	Verstellweg
STC-VH20 / STC-HH20 STC-IHH 15		16	28		
Bestell-Nr.	3101627	TW16A-STC	TW28A-STC		–
STC-HV20 / STC-HA20 STC-IHA 15					
Bestell-Nr.	3101627	–	–		–
STC-VH50 / STC-HH 50 STC-IHH 25		16	28		
Bestell-Nr.	3101589	TW16A-STC	TW28A-STC		–
STC-HH 70		16	28		
Bestell-Nr.	3101588	TW16A-STC	TW28A-STC		–
TW16A-STC TW16VAD / TWVAD				16	15-200
Bestell-Nr.	–	–	–	TW16X	
TW28A-STC TW28VAD / TWVAD				28	15-300
Bestell-Nr.	–	–	–	TW28X	

Spannelemente mit variabler Ausladung TWV

	Schiene		Kreuzhalter kpl.	Gleitbügel kpl. mit 2-Komponenten-Kunststoffgriff		Gleitbügel kpl. mit Knebelgriff		Gleitbügel kpl. mit Hebelgriff		Werkbank-Adapter
	Spannhöhe mm	Schiene mm	für Schiene mm	Ausladung mm	für Schiene mm	Ausladung mm	für Schiene mm	Ausladung mm	für Schiene mm	passend für
TWV16	200	22 x 8,5	22 x 8,5	30-150	22 x 8,5	30-150	22 x 8,5	60-150	22 x 8,5	19 mm 3/4"
Bestell-Nr.	3101740		3101744	3101741		3101742		3101743		TW16AW19
TWV16	200	22 x 8,5	22 x 8,5	30-150	22 x 8,5	30-150	22 x 8,5	60-150	22 x 8,5	20 mm/13/16"
Bestell-Nr.	3101740		3101744	3101741		3101742		3101743		TW16AW20
TWV16	200	22 x 8,5	22 x 8,5	30-150	22 x 8,5	30-150	22 x 8,5	60-150	22 x 8,5	25,4 mm/1"
Bestell-Nr.	3101740		3101744	3101741		3101742		3101743		TW16AW25
TWV16	200	22 x 8,5	22 x 8,5	30-150	22 x 8,5	30-150	22 x 8,5	60-150	22 x 8,5	30 mm/1 3/16"
Bestell-Nr.	3101740		3101744	3101741		3101742		3101743		TW16AW30
TWV28	300	28 x 11	28 x 11	40-175	28 x 11	40-175	28 x 11	110-175	28 x 11	—
Bestell-Nr.	3101706		3101710	3101707		3101708		3101709		—

Spannelemente mit fixer Ausladung TW

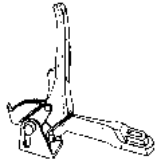
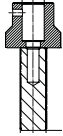
	Schiene		Gleitbügel kpl. mit Holzgriff		Gleitbügel kpl. mit Knebelgriff		Gleitbügel kpl. mit Hebelgriff		Werkbank-Adapter
									
	Spannhöhe mm	Schiene mm	Ausladung mm	für Schiene mm	Ausladung mm	für Schiene mm	Ausladung mm	für Schiene mm	passend für
TW16	200	22 x 8,5	100	22 x 8,5	100	22 x 8,5	100	22 x 8,5	19 mm 3/4"
Bestell-Nr.	3101740		3101516		3101441		3101522		TW16AW19
TW16	200	22 x 8,5	100	22 x 8,5	100	22 x 8,5	100	22 x 8,5	20 mm/13/16"
Bestell-Nr.	3101740		3101516		3101441		3101522		TW16AW20
TW16	200	22 x 8,5	100	22 x 8,5	100	22 x 8,5	100	22 x 8,5	25,4 mm/1"
Bestell-Nr.	3101740		3101516		3101441		3101522		TW16AW25
TW16	200	22 x 8,5	100	22 x 8,5	100	22 x 8,5	100	22 x 8,5	30 mm/1 3/16"
Bestell-Nr.	3101740		3101516		3101441		3101522		TW16AW30
TW28	300	28 x 11	120	28 x 11	120	28 x 11	120	28 x 11	–
Bestell-Nr.	3101706		3101519		3101450		3101525		–
TW28	300	28 x 11	140	28 x 11	140	28 x 11	140	28 x 11	–
Bestell-Nr.	3101706		3101518		3101447		3101524		–







Spannelemente mit Spezialdruckplatte TWM28

	Gleitbügel kpl. mit Knebelgriff und Spezialdruckplatte		Spezialdruckplatte Standard		Spezialdruckplatte mit Riffelung		Spezialdruckplatte mit Prisma	
	Ausladung mm	für Schiene mm	Spindelbohrung mm	Spannstift mm	Spindelbohrung mm	Spannstift mm	Spindelbohrung mm	Spannstift mm
TWM28	120	28 x 11	12	5 x 20	12	5 x 20	12	5 x 20
Bestell-Nr.	3101521		3100736		3101192		3101193	

Spannelemente TW28GRS / TWVAD / TWA-STC / TW28AV

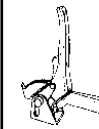
	Schiene		Greifarm kpl.		Verlängerung	
	Spannhöhe mm	Schiene mm	Ausladung mm	für Schiene mm	Loch Ø	Verstellweg
TW28GRS	300	28 x 11	120	28 x 11		
Bestell-Nr.	3101706		3101590		-	
TWVAD TW16VAD TW16A-STC					16	15-200
Bestell-Nr.	-		-		TW16X	
TWVAD TW28VAD TW28A-STC TW28AV					28	15-300
Bestell-Nr.	-		-		TW28X	

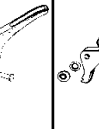
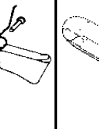
Maschinentischspanner BAS, BS, SGHS

	Druckarm	Druckschuh	Spindel	Gleitbügel kpl.		Hebel mit Druckkappe kpl.	Sperrklinke kpl.	Knebel- aufsatz KA	Einhänger
									
		4 St. im Beutel	2 St. im Beutel	Aus- ladung mm	für Schiene mm	Bolzen-Ø x l mm	Bolzen-Ø x l mm		
BAS...9-4									
Bestell-Nr.	3101428	3101431	3101726	-	-	-	-	-	TW28HO
BAS...10-6									
Bestell-Nr.	3101429	3101431	3101726	-	-	-	-	-	TW28HO
BSP...10-6									
Bestell-Nr.	3101430	-	3101726	-	-	-	-	-	TW28HO
BAS0									
Bestell-Nr.	-	-	-	-	-	-	-	-	TW28HO
BS2N / BS3N							5h11 x 26		
Bestell-Nr.	-	-	-	-	-	-	3100747	-	TW28HO
BS4N							5h11 x 26		
Bestell-Nr.	-	-	-	-	-	-	3100748	-	TW28HO
BS5N / BS6N SG-HS				140	30 X 15	12 X 38			
Bestell-Nr.	-	-	-	3101432		3101029	-	-	TW28HO
GRS									
Bestell-Nr.	-	-	-	-	-	-	-	-	TW28HO
BSG									
Bestell-Nr.	-	-	-	-	-	-	-	3101195	TW28HO

Korpuszwingen KR/KRV

	Unterteil kpl. mit Gleitbügel		Set im Beutel	Tischklemme		Tischklemme		Tischklemme	
	Ausladung mm	für Schiene mm	3 Schutzkappen 2 Auflagen 1 Endsicherung	Spannweite mm	Ausladung mm	Spannweite mm	Ausladung mm	Spannweite mm	Ausladung mm
KR...-2K KRV...-2K	95	29 x 9			60	22	60	28	100
Bestell-Nr.	3101410		3101411	TK6		RB269		LM10/5R8	

Korpuszwingen K/KR/KRV

	Verlängerung	Variables Oberteil		Adapter, schwenkbar		Rahmenpressen-Set
		Ausladung mm	für Schiene mm	Backen- höhe mm	Backen- breite mm	
K...		95	29 x 9			
Bestell-Nr.	KBX20	KR-VO		-		KP
KR...-2K KRV...-2K		95	29 x 9	170	25	
Bestell-Nr.	KBX20	KR-VO		KR-AS		KP

Flächenspanner

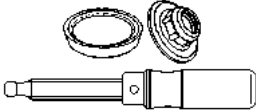
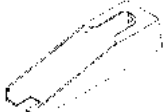
	Spindel kpl. mit Holzgriff	Schutzkappe
		
	Trapezgewinde mm	Ausladung mm
FK16-8		80
Bestell-Nr.	–	3001494
FK...-10	16 x 4	100
Bestell-Nr.	3101386	3001068



Einhandzwinde EHZ

	Schutzkappen-Set
	
	5 Paar
	Ø mm
EHZ...-2K	32
Bestell-Nr.	3101402

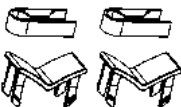

Gripzangen GRZ

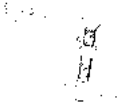
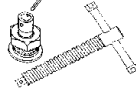
	Schutzkappe für GRZ10 und GRZ20	Schutzkappe für GRZRO
		
	4 Stück	4 Stück
GRZ 10 - GRZ 20		
Bestell-Nr.	3100576	–
GRZRO		
Bestell-Nr.	–	3101547

Sparrenzwinge SPZ60K und SPZ80K

	Gleitbügel kpl.	Kombi-Set Spindel + Spezialdruckplatte + Spannstift		Knebelaufsatz KA	Druckplatte
					
	für Schiene mm	Trapezgewinde mm	Knebel Ø x Länge mm	2 Stück im Beutel	4 Stück im Beutel
SPZ60K	27 x 13	18 x 5	10 x 120		
Bestell-Nr.	3101338	3100398		3101194	3101188
SPZ80K	30 x 15	20 x 5	11 x 120		
Bestell-Nr.	3101330	3100399		3101195	–

Sparrenzwinge SPZ80K

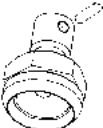
	Spezialdruckplatte Standard		Spezialdruckplatte mit Riffelung		Spezialdruckplatte mit Prisma		Schneidring	
								
	Spindel- bohrung mm	Spann- stift mm	Spindel- bohrung mm	Spann- stift mm	Spindel- bohrung mm	Spann- stift mm	Spindel- bohrung mm	Spann- stift mm
SPZ80K	12	5 x 20	12	5 x 20	12	5 x 20	12	5 x 20
Bestell-Nr.	3100736		3101192		3101193		3101219	

Schraubspanner S10

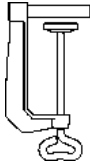
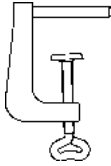
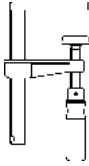
	Tischklemme		Tischklemme		Tischklemme	
						
	Ø 8 mm		Ø 8 mm		Ø 8 mm	
	Spannweite mm	Ausladung mm	Spannweite mm	Ausladung mm	Spannweite mm	Ausladung mm
S10-ST	60	22	60	28	100	50
Bestell-Nr.	TK6		RB269		LM10/5R8	

Einhand-Kantenzwinge EKT

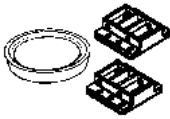
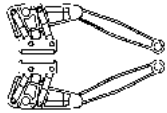
	Ersatzteil-Set	Backen kpl. mit Schubstange
		
	3 Paar Druckbacken und 3 Stück Schutzkappen	2 Paar
EKT55		
Bestell-Nr.	3101403	3100998

Kantenfix KF und Plattenträger KFP

Druckbacken	
	
1 Paar inkl. Feder	
KF2	
Bestell-Nr.	4102100
KF4	
Bestell-Nr.	4102056
KFP	
Bestell-Nr.	4102057



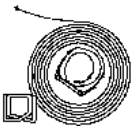

Bandspanner BAN

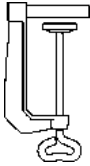
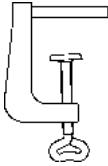
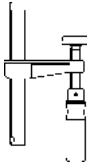
Band Ersatzteil/Verlängerung	
	
Band 7100 mm, 2 Spannschnallen	
BAN 700 / SVH 400	
Bestell-Nr.	3100832

Winkelspanner WS

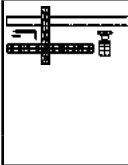
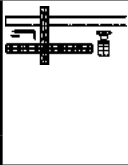
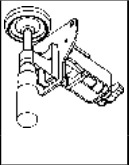
	Tischklemme		Tischklemme		Tischklemme	
	Spannweite mm	Ausladung mm	Spannweite mm	Ausladung mm	Spannweite mm	Ausladung mm
						
	Ø 8 mm		Ø 8 mm		Ø 8 mm	
WS3	60	22	60	28	100	50
Bestell-Nr.	TK6		RB269		LM10/5R8	

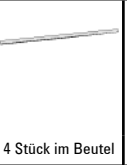
Türfutterstrebe TU

	Druckplatte mit Innenrohr und Klemmstück kpl.	Druckplatte mit Außenrohr und Klemmstück kpl.	Spannbügel breit kpl. inkl. Schiebeteil	Ausleger kpl.	Verlängerung	Filzstreifen	TU Tasche
						 4 Stück im Beutel	
		Innenmaß mm					
TU		25 x 25					
Bestell-Nr.	3100934	3100935	3101752	3101764	TUX	3101632	3101762

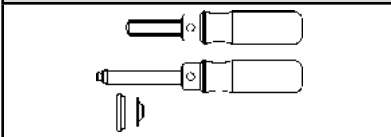

Tür-Futter-Richtzwinge TFM

	2 x Spindel mit loser Druckplatte und Schutzkappe
	
TFM	
Bestell-Nr.	3101408

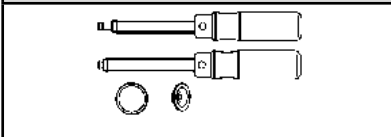

Fenster-Richtzwinge FRK

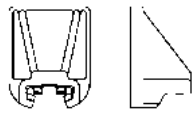
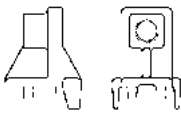
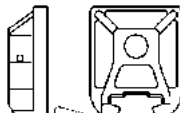
	2 x Spindel mit loser Druckplatte und Schutzkappe
	
FRK	
Bestell-Nr.	3101409

Türenspanner TAN

	Druckbacken		Spindelaufnahme	Spannbacken	Spindel-Set TAN
					
	Backen- breite mm	Backen- höhe mm	Trapez- gewinde mm		
TAN	75	80	20 x 5		
Bestell-Nr.	3005767		3005766	3100919	3101404

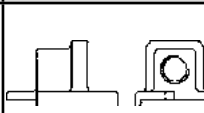
Türenspanner TB

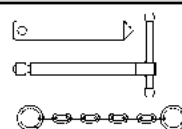
	Druckbacken		Spindelaufnahme	Spannbacken	Spindel-Set TB
					
	Backen- breite mm	Backen- höhe mm	Trapez- gewinde mm		
TB	60 (80)	48	18 x 5		
Bestell-Nr.	3006042		3006040	3100920	3101405

Türenspanner TC

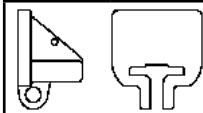

	Druckbacken	
		
	Backen- breite mm	Backen- höhe mm
TC	50 (68)	40
Bestell-Nr.	3006045*	

*solange Vorrat reicht

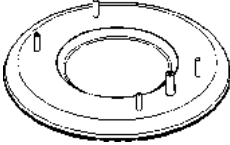
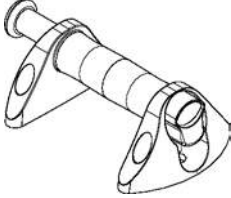



Plattenspanner PS

	Saugspanner	Gummiplatte	Griff
			
	Ø mm	Ø mm	
PS 55	120		
Bestell-Nr.	3005774	-	-
PS 130		210	
Bestell-Nr.	-	3101685	3101686



Blechknabber

	Ersatzmesser	Matrize
		
D24		
Bestell-Nr.	D241	D242

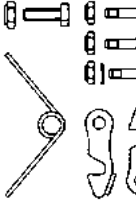
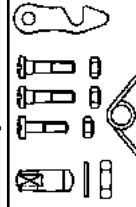
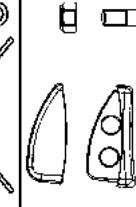

Klingen-Klappmesser

	Trapezklinge	Hakenklinge	Linoleumklinge	Ausstechklinge
				
	10 Stück	10 Stück	5 Stück	5 Stück
DBKPH DBKWH DBKAH				
Bestell-Nr.	DBK-T	DBK-H	DBK-L	DBK-A

Hebelübersetzte Scheren

	Reparatur-Set 08/22A 27/29/123S	Reparatur-Set 16	Reparatur-Set 17A-2	Niederhalter komplett 123S	Rolltasche
					 für 3 Scheren
D08 ... D16A D22A D27AH-TiN/L					
Bestell-Nr.	R032	-	-	-	7002464
D16 / D16L / D16S					
Bestell-Nr.	-	R030	-	-	7002464
D27 ... D29 ...					
Bestell-Nr.	R001	-	-	-	7002464
D17A-2/L					
Bestell-Nr.	-	-	R043	-	7002464
D123 S					
Bestell-Nr.	R001	-	-	R042	7002464

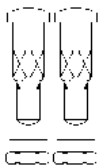
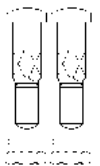
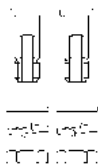
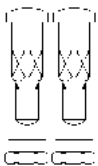
Normalblechscheren

	Verschraubung komplett M6 D8 x 24	Verschraubung komplett M6 D8 x 26	Verschraubung komplett M8 x1 x 22	Verschraubung komplett M6 D8 x 26	Rolltasche
	 <p>2 Stück</p>	 <p>2 Stück</p>	 <p>2 Stück</p>	 <p>2 Stück</p>	 <p>für 3 Scheren</p>
D101-200 – D101-250 D201-200 – D201-250 D102-225 D202-225 D107-225 – D107-275 D207-225 – D207-275 D114-250 – D114-275 D214-250 – D214-275 D159-200 – D159-250					
Bestell-Nr.	R034	–	–	–	7002464
D102-250 – D102-300 D202-250 – D202-300 D106-250 D106A-250 D107-300 – D107-350 D207-300 – D207-350 D208-275 D209-275 D114-300 D214-300 D159-300 – D159-350					
Bestell-Nr.	–	R035	–	–	7002464
D116-260 – D116-280 D216-260 – D216-280 D216-260-B-SBSK D216-280-B-SBSK D118-300 – D118-350 D218-300 – D218-350 D416-280 D 418-300 – D418-350					
Bestell-Nr.	–	–	R036	–	7002464
D407-275 – D407-300					
Bestell-Nr.	–	–	–	–	7002464



Einfach besser.



Ersatzteilliste DE oPr 2016 „c“

www.bessey.de

BESSEY Tool GmbH &Co. KG ■ Mühlwiesenstraße 40
74321 Bietigheim-Bissingen, Germany
Fon +49 (0) 7142 401-0 ■ Fax Inland: +49 (0) 7142 401-451
Fax Export: +49 (0) 7142 401-452 ■ E-Mail: info@bessey.de